

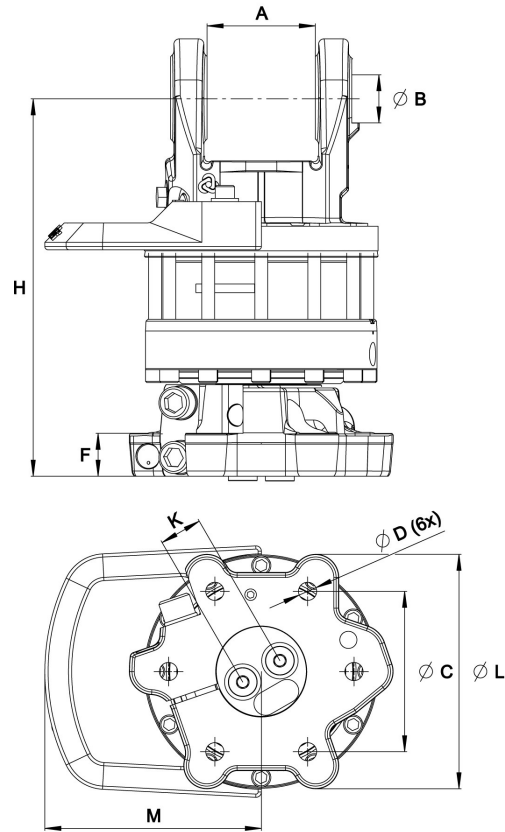

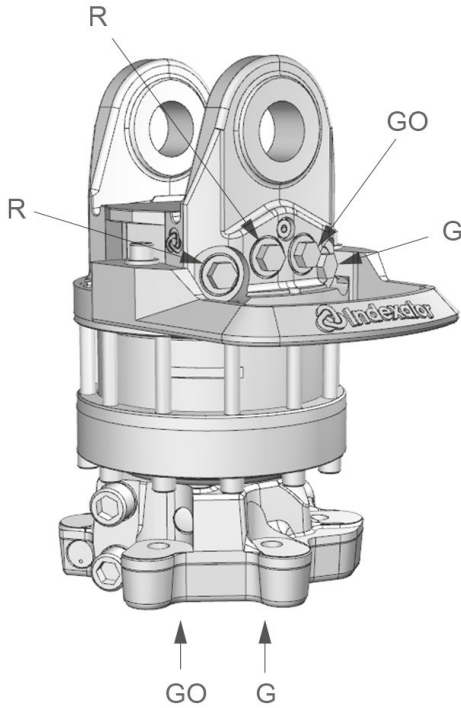







GV 17S A

Part No.: 5217276



Upper connection	Lower connection
G 1/2	G 1/2

A: 101 mm	B: Ø45 mm	C: Ø173 mm	D: Ø17 mm	F: 40 mm	H: 353 mm	K: 40 mm	L: Ø243 mm	M: 202 mm
--------------	--------------	---------------	--------------	-------------	--------------	-------------	---------------	--------------

								
64.1 kg	360°	160 kN	50 kN	3300 Nm	35 l/min	25 MPa	25 MPa	25 MPa

Rotator with only axial connections for a grapple function.

Adapter sets are available for alternative connections.

For further technical information relating to integration and hydraulic connections, please contact rotator@indexator.com