

GV 14S A

Part No.: 5214276

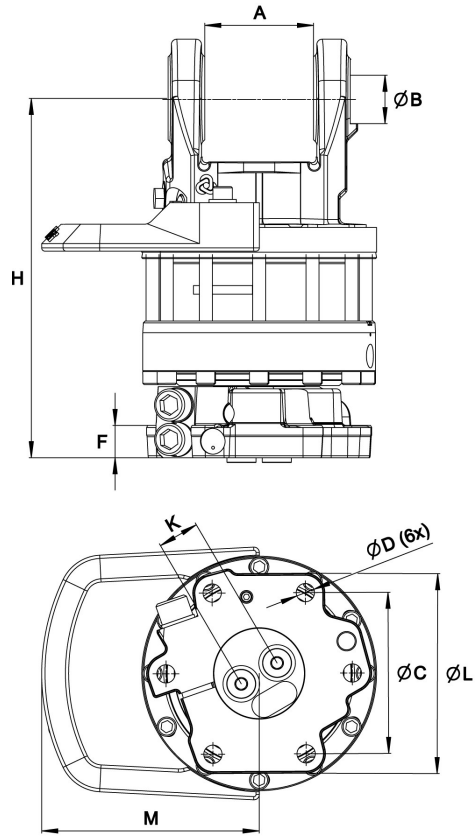
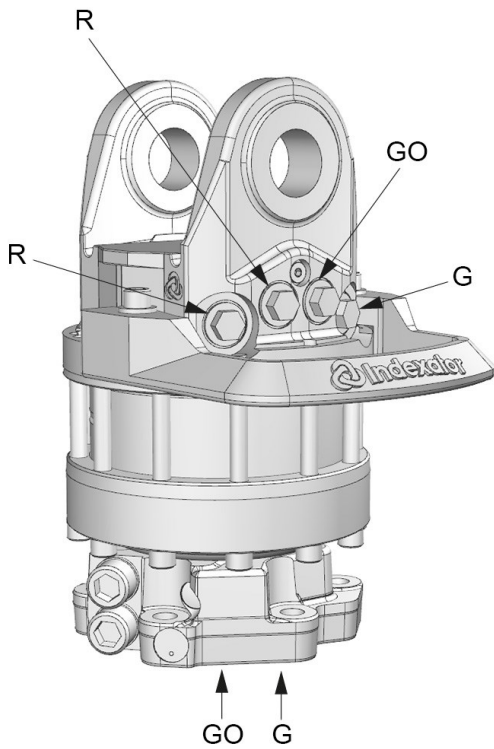

Upper connection	Lower connection
G 1/2	G 1/2

A: 101 mm	B: Ø45 mm	C: Ø173 mm	D: Ø17 mm	F: 30 mm	H: 333 mm	K: 38,5 mm	L: Ø209 mm	M: 202 mm
--------------	--------------	---------------	--------------	-------------	--------------	---------------	---------------	--------------

		Max 	Max 		Max 	Max 	Max 	Max
57.1 kg	360°	100 kN	50 kN	3300 Nm	35 l/min	25 MPa	25 MPa	25 MPa

Rotator with only axial connections for a grapple function.

Adapter sets are available for alternative connections.

For further technical information relating to integration and hydraulic connections, please contact rotator@indexator.com